



DECOPARIS
DECOPROFIL MODENATURE



DECOPARIS



DECOPROFIL MODENATURE

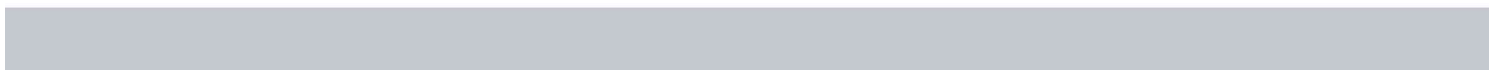
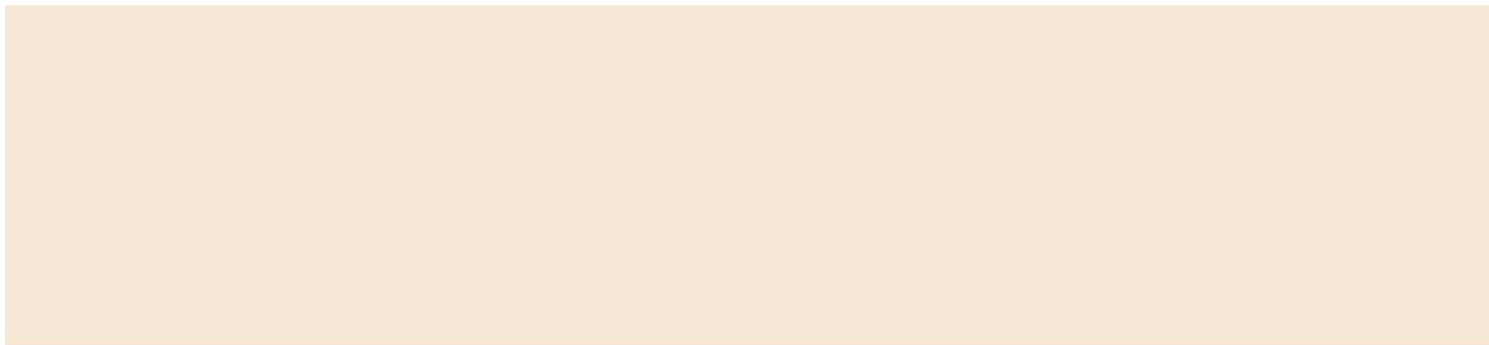
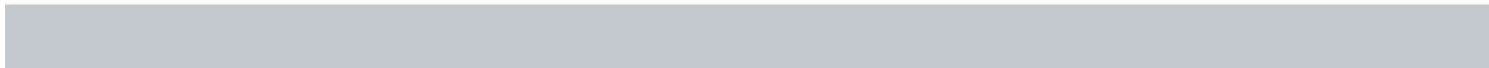

SOMMAIRE

A PROPOS	06
CERTIFICATIONS	07
RESEAUX	08
CORNICHES	10-11
BANDEAUX	13
COURONNE /CORNICHE	15
APPUI DE FENETRES	18
ENCADREMENT DE FENETRES	20
REVETEMENT	22
CHAINES D'ANGLES	23
CHAINES D'ANGLES	24
CORBEAUX	26
REVETEMENT DE COLONNES	28
ETAPES DE MONTAGE	29-30

VOTRE PROFESSIONNEL DE LA DECORATION DE FACADE

Decoparis est une entreprise familiale créée en 2017 par un père et son fils avec l'envie de mettre au service de l'entrepreneuriat une expérience professionnelle de 25 ans dans le domaine de la façade.

Aujourd'hui la société DECOPARIS est titulaire d'un avis technique de ses produits DECOPROFIL MODENATURE mais également de la qualification RGE QUALIBAT. dans les travaux d'isolation thermique par l'extérieur.

Le mot modénature désigne les éléments ornementaux d'une façade extérieure qui contribuent à caractériser le style architectural d'un bâtiment et à mettre en valeur la façade. DECOPARIS réalise sur-mesure, selon les plans fournis, des éléments décoratifs pour façades tels que corniches, bandeaux, moulures, corbeaux, etc. Les éléments sont légers, manportables, faciles à mettre en œuvre et apportent un complément d'isolation.

En fonction des chantiers, DECOPARIS fournit des éléments spécifiques tels que pièces d'angles, solutions pour descente EP, linteaux, ornements, encadrements, etc.

et AVIS TECHNIQUE

Avis technique n° 7/21-1783_V1 publiée le 12/07/2021 et valable jusqu'au 31 juillet 2024 .



AVIS TECHNIQUE

La qualification RGE QUALIBAT
dans les travaux d'isolation
thermique par l'extérieur.



RESEAUX



DECOPARIS.NET

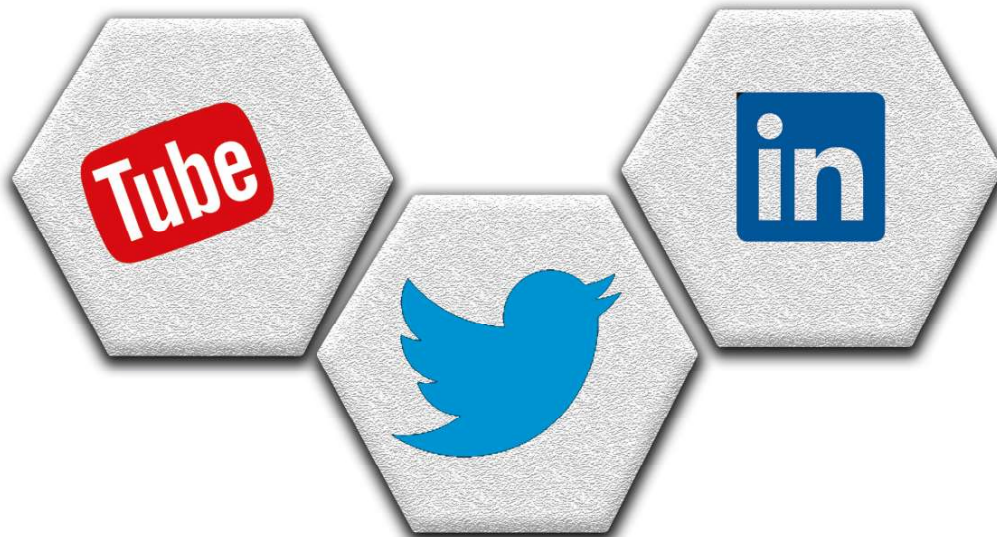

CORBEAUX

BANDEAU

REVETEMENT

APPUIS DE FENETRES

CHAINES D'ANGLES

ENCADREMENT DE FENETRES

CORNICHE

COURONNES

CORNICHES

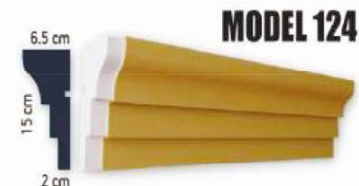
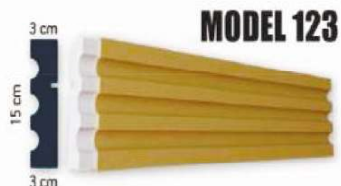
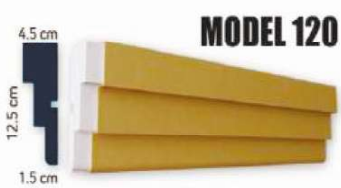
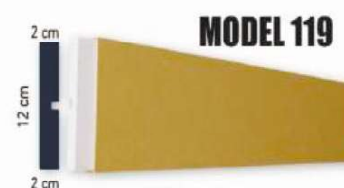
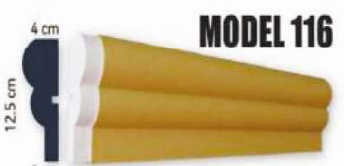
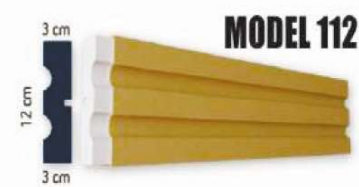
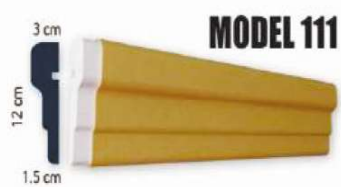
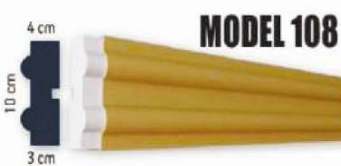
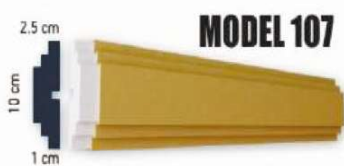
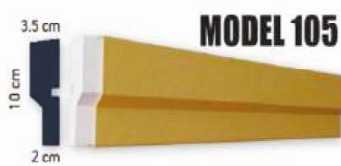
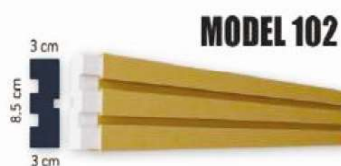
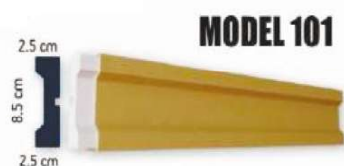

CORNICHES

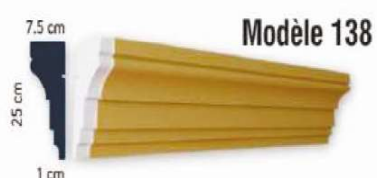
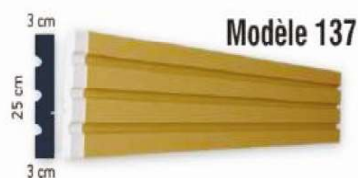
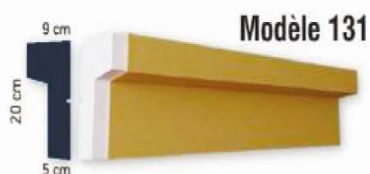
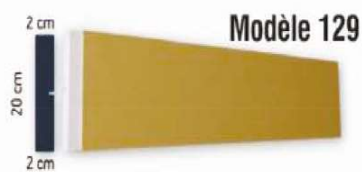
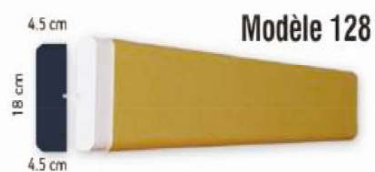
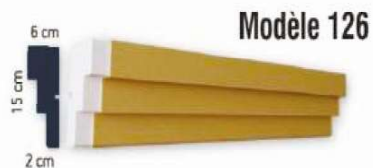
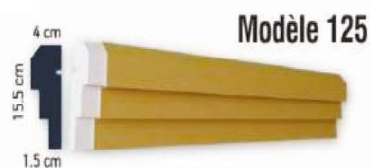



DECOPARIS

BANDEAUX

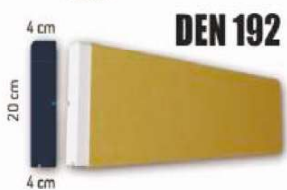
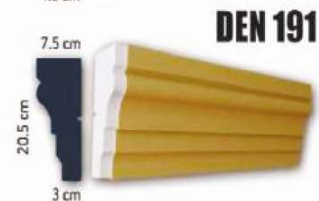
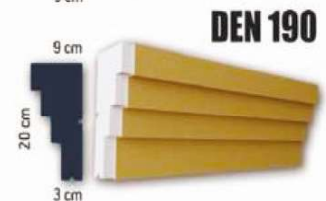
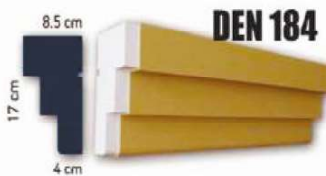



COURONNE / CORNICHE



DECOPROFIL MODENATURE





APPUIS DE FENETRES

Appui de fenetre complet



Nez d'appui



Nez d'appui avec trame

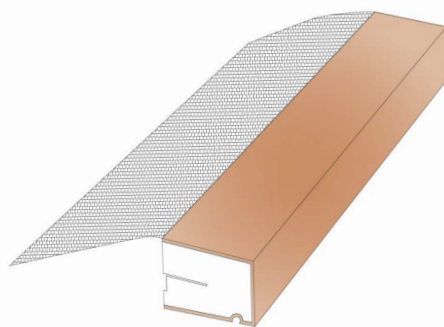



ENCADREMENT DE FENETRES

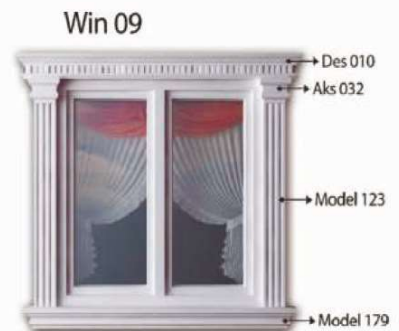
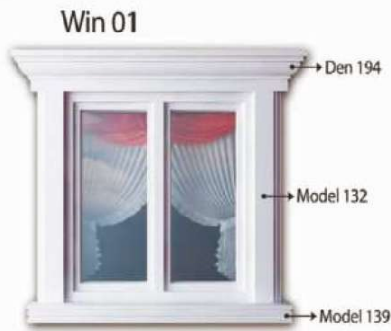



REVETEMENT

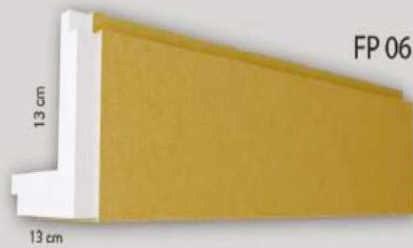
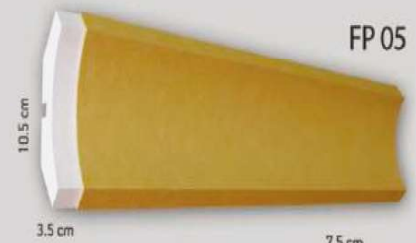
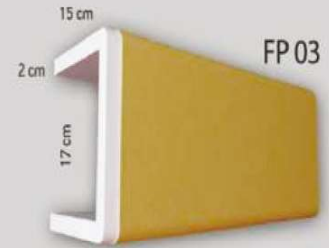
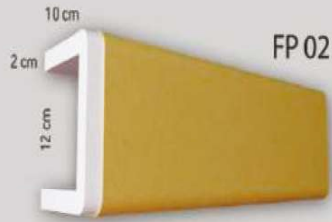

CHAINES D'ANGLES

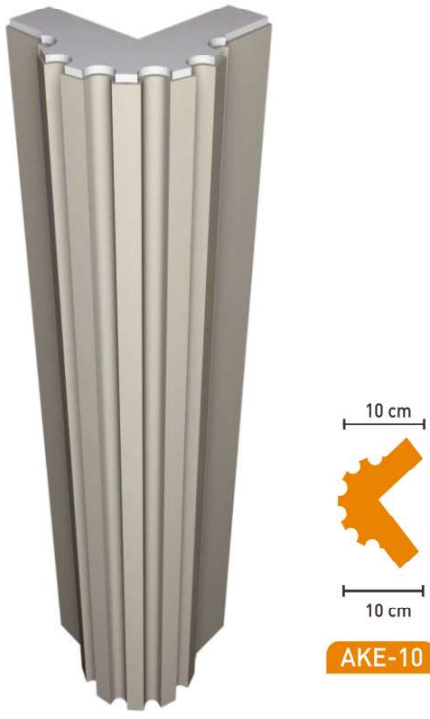
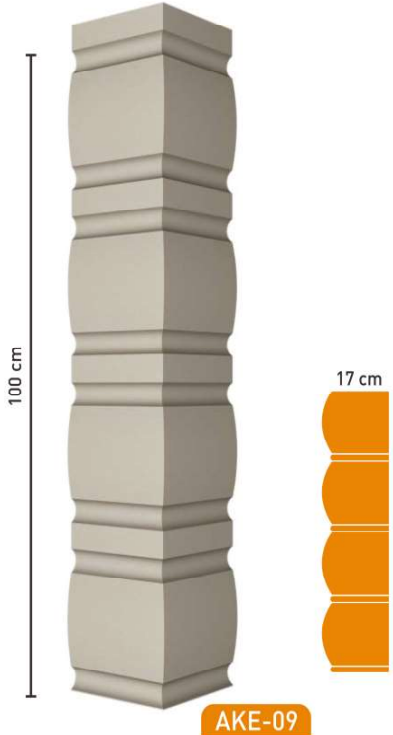
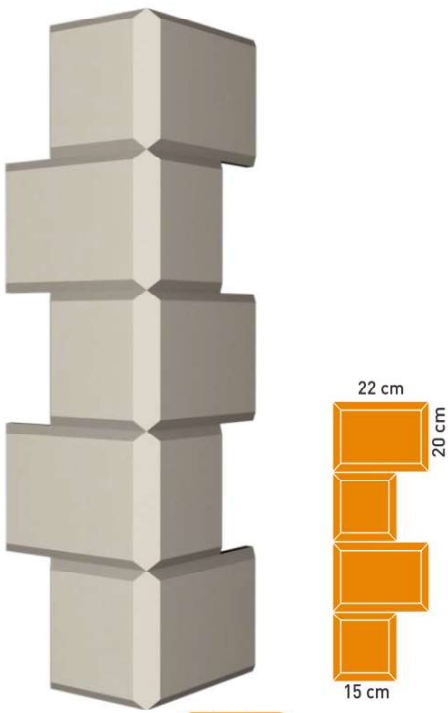
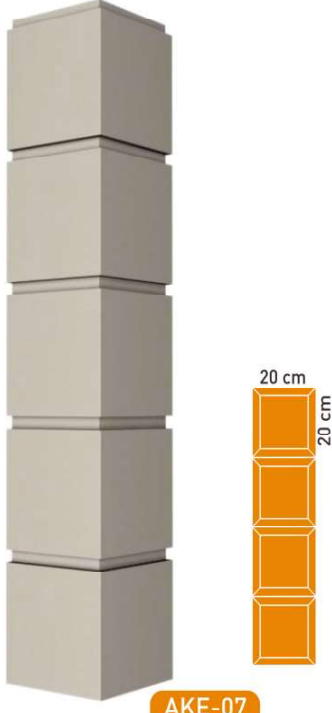
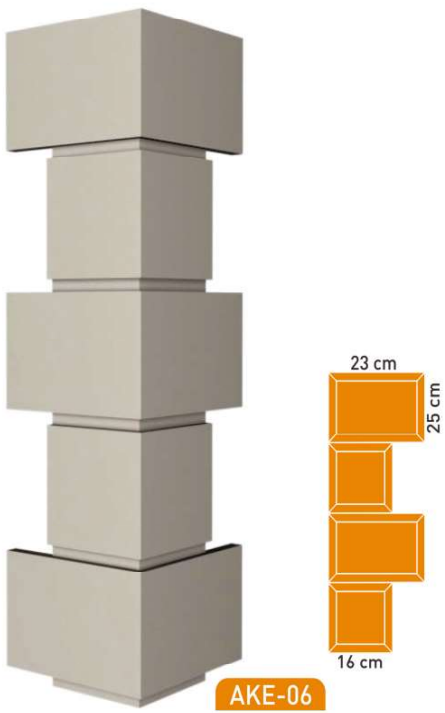

CHAINES D'ANGLES



AKE-01



AKE-02



AKE-11



AKE-03



AKE-04



AKE-05

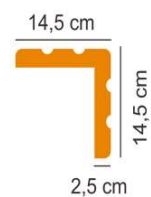

AKE-12

DECOPROFIL MODENATURE

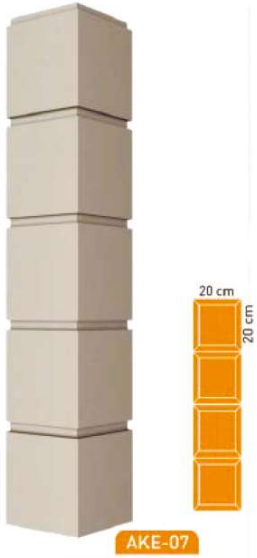

AKE-07

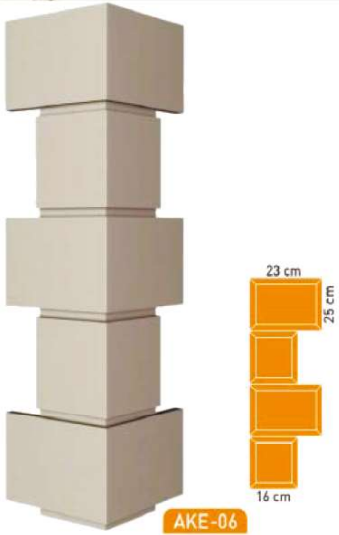

AKE-06

CORBEAUX



AKS 10

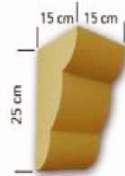

AKS 11

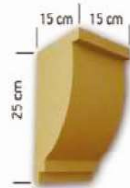

AKS 12

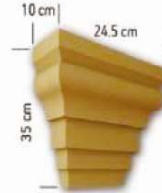

AKS 13

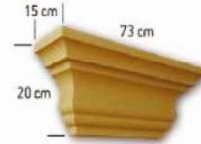

AKS 14



AKS 15

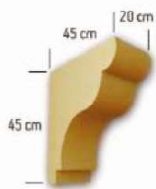

AKS 16

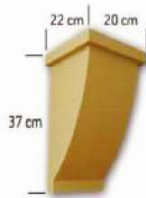

AKS 17

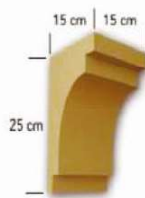

AKS 18

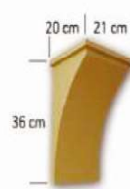

AKS 19

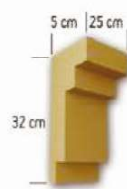

AKS 57

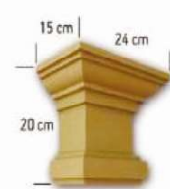

AKS 22

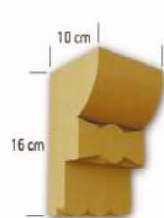

AKS 23

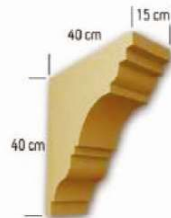

AKS 24

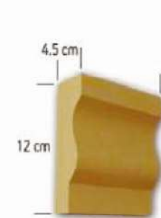

AKS 25

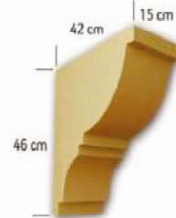

AKS 26

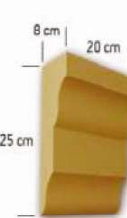

AKS 27

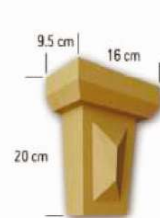

AKS 29

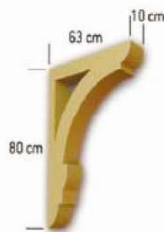

AKS 30

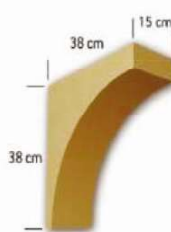

AKS 31

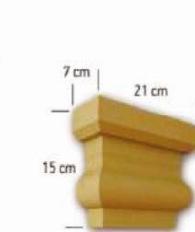

AKS 32



AKS 33



AKS 50

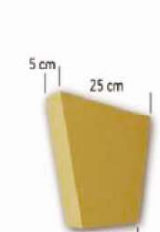

AKS 51



6 cm x 19 cm
AKS 52



5 cm x 20 cm x 20 cm
AKS 53



4 cm x 20 cm x 20 cm
AKS 54-1



4 cm x 15 cm x 15 cm
AKS 54-2



4 cm x 15 cm x 12 cm
AKS 54-3



2 cm x 8 cm x 8 cm
AKS 54-4



1 cm x 4 cm x 4 cm
AKS 54-5



AKS 10

5 cm x 20 cm x 20 cm



AKS 10

5 cm x 20 cm x 21 cm



AKS 10

20 cm x 20 cm x 39 cm



REVETEMENT DE COLONNES



Colonnes 01

20 cm x 10 cm
30 cm x 15 cm
40 cm x 20 cm
50 cm x 25 cm



Colonnes 02

20 cm x 10 cm
30 cm x 15 cm
40 cm x 20 cm
50 cm x 25 cm



Colonnes 03

20 cm x 10 cm
30 cm x 15 cm
40 cm x 20 cm
50 cm x 25 cm



Colonnes 04

20 cm x 10 cm
30 cm x 15 cm
40 cm x 20 cm
50 cm x 25 cm

Colonnes 1T



Colonnes 2T



Colonnes 3T



Colonnes 4T



S 022-1



S 022-2



S 022-3



ETAPES DE MONTAGE

PRENDRE LES MESURES



TRACER SUR LE SUPPORT l'emplacement de la modénature



POSITIONNER LA MODÉNATURE et tracer son emprise sur le support. Repérer la fente prévue pour tracer l'emplacement des guides en «L». Couper si besoin les modénatures aux dimensions (scie égoïne, boîte à onglet etc...)



TRACER L'EMPLACEMENT DES GUIDES EN «L»

- 1 guide tous les 1,20 m minimum (ou sur ITE, tous les 0,60 m)
- Et 1 guide à 5 cm des extrémités d'arrêt et/ou de jonction d'angle de 2 modénatures
- Ces guides facilitent l'alignement des modénatures



TRACER L'EMPLACEMENT DES PERÇAGES DES GUIDES EN «L»

Choisir un trou oblong vertical et 1 trou oblong horizontal, pour faciliter le réglage



PERCER



FIXER LE GUIDE EN «L» au moyen de 2 chevilles adaptées au support



ENCOLLER AVEC LA COLLE PRB FONDISOL F OU PRB THERMICOL

à l'aide d'un peigne U6 l'emprise de la modénature tracée sur le support



ENCOLLER L'ENVERS DES MODÉNATURES avec la colle PRB FONDISOL F ou PRB THERMICOL sur 1 à 2 mm



EMBOITER LA MODÉNATURE sur le profilé en appuyant et en exécutant un mouvement de glissement sur le profil, afin d'obtenir un bon transfert et un collage à bain plein



ENDUIRE LES EXTRÉMITÉS DES MODÉNATURES avec du PRB FONDISOL PE blanc sur 1 à 2 mm d'épaisseur



PLACER LA MODÉNATURE SUIVANTE au contact de la première, pour que le joint en FONDISOL PE BLANC soit bien collé



SUPPRIMER L'EXCÉDENT DE COLLE

À l'aide d'un couteau à enduire, supprimer la colle qui déborde de la modénature et des jonctions



FERMER ET LISSER LES JONCTIONS

pour obtenir un support plan ou légèrement en creux, afin d'obtenir des joints



FINIR LES EXTRÉMITÉS en lissant avec le FONDISOL PE BLANC



PUIS FINIR LE CHANTIER

- Enduit sur le mur
- Mastic MASS FLEX ou MASS MS aux jonctions supérieure et inférieure, entre l'enduit et la modénature
- Peinture décorative sur la modénature
- Bavette métallique fixée mécaniquement au support et avec une colle de type MASS MS sur le dessus de la modénature (voir exemple de montage page précédente)

ETAPES DE MONTAGE

TRACER L'ANGLE À COUPER



COUPER LA MODÉNATURE (scie égoïne, boîte à onglet, etc...)



PRIORITÉS AUX VERTICALES

démarrer toujours par le tracé des modénatures verticales



TRACER ENSUITE LES HORIZONTALES

poursuivre par le tracé des modénatures horizontales



POSITIONNER LES MODÉNATURES COUPÉES puis tracer leur emprise sur le support



TRACER L'EMPLACEMENT DES GUIDES EN «L»



TRACER L'EMPLACEMENT DES PERÇAGES comme expliqué page précédente



PERCER



FIXER LES GUIDES EN «L»



COLLER LES MODÉNATURES



FINIR LES JOINTS



AUTRE EXEMPLE DE COUPE D'ANGLE





DECOPARIS

☎ DECOPARIS - Tél : 09 53 12 37 87 - 06 95 92 99 14

✉ decomatparis@gmail.com – www.decoparis.net

📍 4 Avenue Pierre Salvi , bat 8 , 95500 GONESSE

Siret : 751162033 00052 – SARL au capital de 24 000.00